

Practical hints for the installation of strain gages

by Karl Hoffmann

Special notice

All methods and materials mentioned or recommended in this document are reliable and suitable for the purpose intended according to our knowledge and experience, and are state of the art. They are to be understood as an assistance or general advice for the user of strain gages. However, in view of the variety of installations and the complexity of the conditions of use neither the company, Hottinger Baldwin Messtechnik, nor the author can give any guarantee whatsoever nor will they take liabilities of any kind. For critical cases it is recommended to undertake a special pretest, which takes all special conditions of use into account. It is the responsibility of the user to observe all relevant safety and operational rules.

Neither the editor nor the author has any knowledge of patent or similar rights, which might be infringed by their recommendations. Nevertheless, an infringement may not be excluded for sure.

Note:

Figures in brackets refer to the literature.

© 1979

4th revised edition 1996

Printed in the Federal Republic of Germany

All rights reserved. Complete or partial reproduction in any form or translation requires previous written consent of the author or the editor. Photocopies of parts for personal use are permitted.

Contents

1	Introduction	5
2	The installation of strain gages.....	8
2.1	Duty and function of the bonding agent	8
2.2	Kinds of adhesives	9
2.2.1	Characteristics of different HBM strain gage adhesives.....	12
2.3	The application of the adhesives	13
2.3.1	Preparation of bonding surfaces on metals	13
2.3.2	Preparation of bonding surface on non-metals.....	19
2.3.3	Strain gage installations in medicine	23
2.3.4	Preparation of the strain gages.....	23
2.3.5	Bonding process	29
2.3.6	Precautions	34
3	Connecting the cables.....	36
3.1	Soldering tools, soldering materials, wiring.....	36
3.1.1	Soldering irons	36
3.1.2	Bits for the soldering iron	36
3.1.3	Solders (soft solders).....	37
3.1.4	Fluxes	38
3.1.5	Solder terminals	39
3.1.6	Lead materials	39
3.2	Practical hints	42
3.2.1	Hints for soldering	42
3.2.2	Hints for the connection of cables	45
4	Intermediate tests	47
4.1	Visual inspection	47
4.2	Electrical continuity of the strain gage	47
4.3	Resistance of the connection cables	47
4.4	Insulation resistance of the strain gage	47
4.5	Insulation resistance of the connection cable	48
5	Protection of the installed strain gage	49
5.1	Some hints for the use of protective covers for installed strain gages.	50
5.2	Popular protecting materials	51
6	Literature	54

1 Introduction

Strain gages are intended for the measurement of strain. The result of such measurement may be used for statements concerning the material stresses in the specimen, the nature and amount of forces acting on the specimen, etc. However, a strain gage can only perform its task properly if the strain to be measured is transferred faultlessly and free of loss. For that purpose, an intimate connection is required between the strain gage and the object to be measured. The required intimate, plane connection between the specimen and the strain gage is best performed by special adhesives. Other bonding agents and methods are limited to special application areas, e.g. ceramic bonding agents for high temperature installations and spot welding for applications on steel constructions.

Consequently, the quality of the installation greatly influences the accuracy of the measurement. One could say that a strain gage, as delivered, is not a ready-made measurement tool but, through the bonding, the user himself makes it ready for use.

Strain gages and their installation form a unit. Through comprehensive comparisons with other combinations, it is possible to determine which part of the present combination contributes most to errors and to what extent. Therefore, it is strongly recommended to use proven application means and methods if the test equipment described in [1] is not available and if the very comprehensive and expensive tests cannot be carried out. All parts belonging to the "measurement point" (i.e. strain gages, bonding means, protection materials and other accessories) have been put through a comprehensive series of tests to determine their effectiveness, reliability and compatibility before they have been included in the range of products. Their properties are checked constantly using normal quality assurance methods. The reliability of such parts is beyond question if they are used in accordance with the rules. However, a guarantee cannot be given if they are combined with products of other origin or if not used as prescribed.

The bonding agent itself as well as its careful and skilled use, contribute to success or failure. The instructions for use supplied with the bonding agents contain all necessary information and instructions, which the user should strictly observe in his own interests.

Careful preparations are necessary for the optimum measurement, especially for larger measurement tasks. Preparations include planning, material and disposition of personnel. Only skilled personnel can guarantee success. HBM has given training courses for technicians and engineers, in order to provide interested persons with the necessary special expertise.

Facts to be given to the strain gage technician include information about the nature, amount and use of all measurement means required. Here the test leader must give clear advice based on his knowledge of the measurement task and other conditions of the experiment. Table 1.0-1 gives some guidance here.

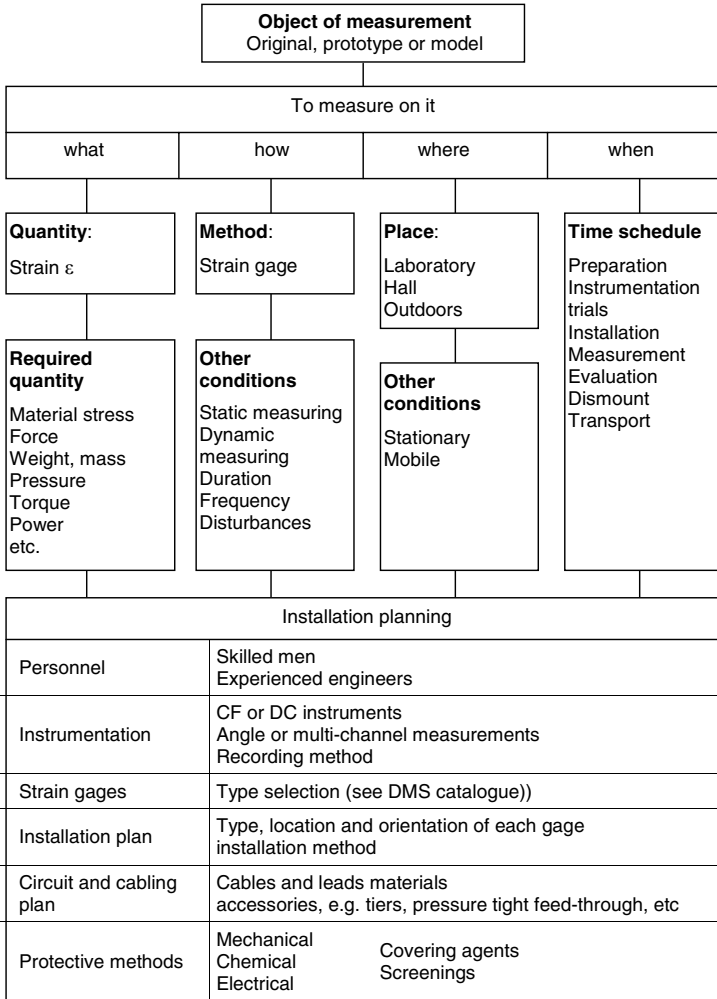

Table 1.0-1: Schematic of installation planning

The installation technician must have details of the following:

- Location of installation and grid orientation with respect to specimen (drawing of the installation, plan of measurement points)
- Circuit plan, layout of cabling
- Strain gages to be used
- Fixing method and means (e. g. a special type of cement)
- Lead material (type of cables, cross section, insulation, etc.)
- Protective measures against mechanical, chemical, electrical, thermal or other effects that may impact the measurement point or the leads.

Final decisions may be based on technical information, e.g. [2], [22] or technical literature. The question of suitable protection is very difficult to answer because of the wide range of potential disturbances or other adverse effects. In many cases, a decision can only be made after comprehensive trials under actual conditions.

A maximum of reliability together with expert knowledge, skill and experience is required of the installation technician.

2 The installation of strain gages

2.1 Duty and function of the bonding agent

Bonding agents connect the strain gage firmly to the surface of the specimen in order to transfer the deformation of the specimen correctly to the gage. Various conditions and influences as well as consideration of the applicability require different bonding agents and installation methods. Bonding plays a most prominent role. Special advantages afforded by this method of connection in view of its suitability for strain gage installations are:

- Possibility of connecting various materials, even dissimilar ones. Depending on the type of cement, the connection is carried out at room temperature or at elevated temperatures.
- No reaction on the materials to be connected, restrictions only in the case of plastic materials.
- Most chemically curing adhesives (only those are important for the strain gage techniques) are distinguished by a low humidity absorption (except cyanoacrylate).
- Control of the working speed by selection of different cement types or curing conditions (cold or hot curing).
- High electrical resistivity contributes to a high insulation resistance between the gage and the specimen.

The connection of bonded parts relies on the adhesion between the cement and the surface of the specimen. Adhesion is primarily based on adhesion forces between neighbouring molecules. The contribution from clamping action in the pores of the roughened surface or from capillary action is only small. Any increase of the bonding stability in moderately roughened surfaces is due to the increase of the effective surfaces, and not on mechanical adhesion.

Note 2.1-1:

The nature of adhesion is quite complicated and only partly investigated [3, 4]. An important part of the bonding forces is due to adsorption, a smaller part is due to chemical bonding or other sources of energy.

The term "Van der Waals' forces" combines various bonding mechanisms of the adsorption type, which are basically distinguished in three kinds of reciprocal orientation effects:

- The dipole moment (Keesom forces). If negative and positive charges in a molecule are distributed asymmetrically, the molecule will be neutral but has a dipole moment, i.e. it is polar. Neighbouring molecules try to align their dipole moments so that the molecule side with positive charge faces towards the negative side of another molecule and vice versa. The average range of the Keesom force is 0.4 to 0.5 nm (4-5 Å).
- Induction effects (Debye forces). If the centres of gravity of the charge in the electrical field of a molecule are shifted by the inductive effect of an outer field (e.g. from another molecule), interactions are produced. Unlike Keesom forces, in the case of Debye forces, one particle has a permanent dipole and the other an induced dipole moment. The average range of the Debye forces is 0.35 to 0.45 nm (3.5-4.5 Å).
- The dispersion effect (London forces). This effect is explained by undulatory mechanics considerations whereby the constantly changing centres of gravity of electrical charges leads to in-phase undulatory

systems of two particles, thus constantly inducing a dipole. The average range of the London forces is 0.35 to 0.45 nm. (3.5-4.5 Å)

A special position within the range of the Van der Waals' forces is the hydrogen bridge, which is also due to the mutual action of oriented dipoles. The peculiarity is that the positive pole of at least one dipole is formed by a hydrogen atom. The range of the hydrogen bridge is 0.25 to 0.3 nm (2.5-3 Å). The contribution of the chemical linking forces is only investigated to a small extent. From experience so far, it seems that these forces only contribute to a less amount to the adhesive forces.

2.2 Kinds of adhesives

Various kinds of adhesives are offered depending on the working conditions at the place of installation and the various requirements of the effectiveness of the adhesives, especially, service temperature. The same conditions apply to the strain gage itself. Thus matching is achieved between certain strain gage and type of adhesives, which offer optimum properties, in a limited range of applications. Other combinations with dissimilar effectiveness mean that the component with the narrower limits determines the range of installation. Furthermore, there are combinations of strain gages and adhesives, which are excluded for technological reasons. In each case, the recommendations given in the technical leaflets should be closely considered.

Note 2.2-1:















Never use adhesives other than those recommended. Strain gage adhesives must fulfil other requirements than those used purely for mechanical connections. They are usually the result of special developments or are at least modifications of commercially available adhesives. The firm mechanical fixation of a strain gage is not a sufficient criterion for the suitability of the adhesive for measurement purposes. This requires more stringent investigations and strain gage tests according to [1] automatically include the adhesives.

Depending on the installation technology, one can differentiate between:

- Cold curing adhesives
- Hot curing adhesives
- Spot welding

- Cold curing adhesives

are easy to apply and require only little effort. One distinguishes between single component adhesives that, for example, start curing when air is excluded (anaerobic curing), and two component adhesives that have to be mixed before the installation. Their preferred application is in experimental stress analysis or related installation areas.

1	2	3	4
Adhesive name	Main application area	Base material	Usable temperature range (approx.) for absolute  ¹⁾ for relative  ²⁾ measuring -200 0 +200 400 600 800 °C
X60	Experimental stress analysis, also on porous material	Methacrylat mixture	 
Z70	Experimental stress analysis, on non-porous material only	Cyanoacrylate	  For permanent use: lowest temp. -55°C
X280	Experimental stress analysis	Epoxy resin	 
EP250	Experimental stress analysis at elevated temperature Precision transducers also on porous material	Epoxy resin	 For transducers  
EP310S	Experimental stress analysis at elevated temperature Precision transducers on non-porous material only	Epoxy resin	 For transducers  
Spot welding method	Experimental stress analysis	-	Temperature limits depend on gage only

- 1) Measurements with reference to a zero point ("static measurements")
- 2) Relative measurements (dynamic measurements)
- 3) Pot life is the time between mixing the components of the adhesive at 20°C until jelling; is shorter at higher temperatures and vice versa.
- 4) The figure in **bold type** indicates the preferred value, others are alternatives or limits.
- 5) Strain gage series comprising several gage types are distinguished by carrier material or design properties. The letters indicate the carrier material:
G) Phenolic resin with glass fibre (foil gages)
Y) Polyimide carrier (foil gages)
S) Steel laminate (weldable gages)

Table 2.2-1: Overview of strain gage adhesives in the HBM product range and their combination possibilities with different ranges of strain gages

5	6	7				8	9	10				
		Curing temp. [°C]	Curing time		Clamping pressure ³⁾ [bar]			Glue line [µm]	Modulus of elasticity [kN/mm ²]	Suitable for strain gages of series ⁵⁾		
	1) 4)		2) 4)			G	S			Y	K	E
2	3...5min	0 20 30	90 min 30 min 20 min	60 min 15 min 10 min	Finger pressure	65 ± 15	4,5...6	<input type="checkbox"/>	<input type="radio"/>	<input type="checkbox"/>	<input type="checkbox"/>	-
1	-	5 20	120 min 15 min	90 min 10 min	Finger pressure	6 ± 2	3	<input type="checkbox"/>	-	<input type="checkbox"/>	<input type="checkbox"/>	<input type="checkbox"/>
2	30 min at RT	RT 65 95	8 h 2 h 1 h		0,5 ... 15	40 ± 20	-	<input checked="" type="radio"/>	-	<input type="checkbox"/>	<input checked="" type="radio"/>	<input type="checkbox"/>
2	24 h	95 120 180 200	- 4 h 1+2 h ½ + 2 h	16 h 2 h 1 h ½ h	1...8...15	25 ± 10	2,8	<input checked="" type="radio"/>		<input checked="" type="radio"/>	<input checked="" type="radio"/>	<input checked="" type="radio"/>
2	4 weeks; 12 months at -32°C	180	- 1+2 h ½ + 2 h	5 h 2 h 1 h ½ h	1...5...10	10 ± 5	2,8	<input checked="" type="radio"/>	-	<input checked="" type="radio"/>	<input checked="" type="radio"/>	<input checked="" type="radio"/>
-	-	-	-	-	-	-	-	-	<input checked="" type="radio"/>	-	-	-

Legend to symbols

- Optimum combination and strain gage and adhesive
- Well suited but sacrificing part of the temperature range of gage or adhesive
- Suitable but great disparity of gage and adhesive properties
- Unsuitable combination

(The narrower performance range of the gage or the adhesive is valid for the combination of both! See further details in the relevant leaflets.)

- Hot curing adhesives
are only installed if the specimen can be heated to the temperature required for curing. Generally, this is only possible in the production of transducers, but is also possible in cases where constructional parts can be gaged before mounting or can be removed for gaging. Unlike cold curing adhesives, the hot curing ones offer a wider application range at higher temperatures and meet higher requirements of accuracy usually in combination with precision gages in the production of transducers.
- Spot welding
is also a simple installation methods. It requires only little expenditure in equipment (a small spot welder), little preparation and training. However, it is not commonly used because:
 - Special gage types are necessary and only a few types are available.
 - Weldable gages can only be manufactured down to certain sizes, which further limits their application range.
 - The specimen must be made of a weldable material. This kind of installation is prohibited for some specimens despite weldability because of the danger of micro-corrosion, e.g. on highly stressed parts of vapour vessels, on austenitic steels and such like. The specimen should be thick enough in order not to disturb the stress distribution due to the relatively high reaction force of the weldable gage, i.e. there should be no noticeable obstacle to the strain.

Table 2.2-1 shows all types of strain gage bonding offered by HBM as well as their most important technical data and parameters of use.
- Additional characteristics of various HBM strain gage adhesives, further to the information listed in table 2.2-1.

2.2.1 Characteristics of different HBM strain gage adhesives

- X60 - Methylmetacrylate, cold curing
This adhesive is preferred for stress analysis in the temperature range of approx. -20... + 50°C. It can however also be used for measurements down to -200°C. Its pasty consistency makes it suitable for use with strain gages on porous, sealing materials. Its popularity among installation technicians relies on its uncritical use. The effort of mixing both components before each bonding process compares favourably with a pot life of about 3 minutes (at room temperature), which is long enough to allow complicated installations (e.g. when access to the bonding spots is difficult) but short enough to avoid costly waiting times.
The use of X60 for the production of transducers is recommended only in certain cases, for simple versions with permissible inaccuracies of a few percent.
- Z70 - Cyanoacrylate, cold curing
This adhesive, which cures within seconds, permits - and requires - high speed of operation. This requires some skill and good access to the installation position. Better accuracy of measurement is achieved because of the extremely thin glue line and the higher temperature limits, when compared to X60. This is especially true for the temperature range from 50°C up to the upper temperature limit.
Z70 is suitable for the design and production of transducers in the medium to higher accuracy classes.

- X280 - Epoxy, cold or hot curing

This adhesive is intended for installations where the measurement point is exposed to high temperatures, but an installation using a hot curing adhesive is not possible. X280 allows static examinations up to 200 °C and dynamic examinations up to 280 °C. Nevertheless, the adhesive hardens within 8 hours at room temperature.

X280 is also suitable for use on porous materials. Its use in transducer construction cannot be recommended.

- EP250 - Epoxy, hot curing

This hot curing two-component cement is suited for stress analysis in a larger temperature range as well as for transducer production. If combined with strain gages of K or G series, EP250 is best suited for use in transducers that are to meet high precision requirements.

- EP310S - Epoxy, hot curing

This hot-curing two-component cement is free of fillers, which makes it possible to achieve very thin gluelines similar to Z70. Unlike EP250, this results in a very small reaction force of the installation, even better strain transfer onto the gage and improved measurement accuracy. In the field of experimental stress analysis, this cement is preferred, when compared with the cements previously mentioned, for higher temperatures or for extremely low temperatures.

In combination with K and G series gages, EP310 is particularly suitable for use in transducers of the high precision class.

2.3 The application of the adhesives

Strain gages may be fixed to nearly all solid materials. The prerequisite for this is a suitable and careful preparation of the installation spot. Further details of suitable methods are given in the relevant instructions for use of the adhesives and in the following chapters.

Note 2.3-1:

The information given below is more comprehensive than in the instructions for use for the adhesives. However, it is still not possible to cover all properties of bonding agents completely. If there is a contradiction between the information given here and a special point in the instruction, the latter prevails.

2.3.1 Preparation of bonding surfaces on metals

The kind and extent of preparation depend on state of the specimen, the amount and type of dirt present, as well as the material type of the specimen. The following schematic lists all the pre-treatment of metallic objects. The aim is to provide a surface free from pores, cracks and oxide layers, which is not too rough but easily wetted. The individual steps that are to be undertaken when preparing the measuring point are shown in table 2.3.-1 and described below. The measures that should be taken and the means that should be used depend on the actual state and size of the object as well as its susceptibility to damage. The installation technician should take sensible decisions according to the actual case.

<ul style="list-style-type: none"> ■ coarse cleaning ■ smoothing ■ cleaning ■ roughening ■ cleaning ■ marking 	<ul style="list-style-type: none"> ■ final cleaning and degreasing ■ alternatively pickling, rinsing, and drying
---	--

Table 2.3-1: Preparation steps for the strain gage application

Further clarification of the terms “cleanliness” and “pollution” in a technical sense is essential to ensure that the installation technician is fully familiar with them.

Each open-faced plane is considered in principle as polluted even if it seems neat and clean to the eye. Deposits of dust, oxides, adsorption of humidity, vapours and gases constantly occur, which adversely affect the bonding properties of the cement. Therefore, the bonding should be carried out immediately after the bonding surface has been cleaned. Pauses between the individual cleaning steps are forbidden. Even under laboratory conditions and optimum ambient air conditions, the maximum waiting time between cleaning and installation is 3 hours. Fast oxidising materials (e.g. copper, aluminium, titanium and their alloys) or industrial atmospheres require **immediate** bonding directly after the cleaning.

- Coarse cleaning

Rust, scale, paints, thick layers of lubricants or dirt, other surface layers or pollutants should be removed over an area much larger than the measurement point. Tools to be used for this procedure are scrapers, spatulas, grinders or similar. For coarse cleaning, scouring agents e.g. Vim®, Ata®, Imi® solutions, etc.) are recommended for removing grease or lubricant layers. Caustic soda is also good for removing grease but should be applied with great care. It heavily cauterises the skin therefore rubber gloves and protective glasses should always be worn when using caustic soda.

Attention! Never use caustic soda on aluminium!

Rinse thoroughly with clear or distilled water afterwards. Sufficient degreasing is shown by an unbroken water film. Then dry with clean cellulose pads.

- Smoothing

Rust, scars and deep scratches produce notch strains in the surface of the specimen and lead to incorrect measurements. Humps and other unevenness impair the bonding of the gages. Therefore, the bonding area must be smoothed by grinding, filing or other suitable methods. Grinding tools with exchangeable emery paper and rubber plates are best suited for this. The rubber plate will follow the contour of the object and the emery grade can be selected according to the task. Start with a coarse grade and proceed in steps towards finer grades. To avoid any misunderstanding: The bonding surface does not need to be flat, a gage might be bonded to curved surfaces but the surface must not be humped. Coatings of lead, cadmium, tin, indium, bismuth and similar metals bind poorly or not at all to cements and must be removed completely. Nickel coatings may peel off and should also be removed.

- Cleaning

In this step dirt, grinding dust and grease are to be removed. Cleaning should be thorough but need not be done extremely carefully because more steps are to follow. Organic solvents are recommended as cleaning agents. Further details are given below under “final cleaning”.

Mineral oils, such as those that are used for rolling sheet metals or boring liquids, are only partially removed by the usual organic solvents. In these cases alkaline agents are better.

- Roughening

Note 2.1-1 of section 2.1 explains that bonding forces between specimen and the cement are mostly of a chemical nature. It is possible to increase the bonding forces by enlarging the contact surfaces. Enlargement of the surfaces however is only possible by roughening. This is mostly done mechanically and only seldom chemically by pickling.



Fig. 2.3-1: Influence of surface roughness on efficient contact area

- a) contact line with ideally even area
- b) extended contact line by moderate roughening (optimum condition)

- Roughening by sandblasting

Sandblasting produces an ideal bonding surface. Basic requirements for flawless surfaces are compressed air free of oil or water, clean, unused blasting media and completely degreased surfaces, since grease particles hammered into the surface by the blasting particles cannot be easily removed (ultrasonic cleaning equipment may be necessary).

Blasting carborundum is recommended as blasting agent. It is sharp edged, hard and clean, does not cause corrosion and is physiologically safe (no risk of silicosis). Borocarbide is proven for very hard materials (e.g. hard metals). This blasting agent has a hardness between diamond and carborundum. The grading depends on the hardness of the specimen, air pressure, distance between nozzle and object, and on the type of equipment used. Rule of thumb figures are given in table 2.3-2.

Material of specimen	Roughening by sandblasting				Grinding with emery grade
	Air pressure [bar]	Distance [cm]	Carborundum		
			Grain no.	Particle size [µm]	
Hardened steel	4	20	80 ... 100	160 ... 115	80 ... 100
Mild Steel	4	20	100 ... 150	115 ... 75	100 ... 180
Aluminium and alloys	3	25	F 240 F 320	45 ... 29	220 ... 360

Table 2.3-2: Standard values for grades of blasting carborundum or emery paper for the roughening of specimen for gaging.

A smaller amount of roughening or finer grading is recommended if cyano-acrylate cement is used (e.g. Z70) whereas deeper roughening is best if ceramic bonding agents are used. Standard values for optimum surface roughness (r.m.s. values) are listed in table 2.3-3.

Strain gage bonding agent	Mean roughness
X60	3 ... 10
Z70	2 ... 4
X280	2 ... 10
EP250 and EP310S	2 ... 4

Table 2.3-3 Recommended roughness of the bonding surface on the specimen for various strain gage cements.

- Roughening by emery paper

Despite the obvious advantages of sandblasting its use is limited, sometimes because the equipment is not available, sometimes because the object does not allow this (thinking of bearings near to the bond). In that case, the well-proven emery paper can be used. If properly used, the results are quite satisfactorily. Rub the paper in circles over the surface. Circling is recommended to avoid the privileged stress directions, which would reduce the stability. Only use new emery paper (or cloth) of a grade suitable for the materials. Standard values are also listed in table 2.3-2. Recommended surface roughness values are listed in table 2.3-3.

- Roughening by other mechanical methods

Sometimes even emery is too coarse for very delicate objects and cannot be allowed. This is particularly true for materials that are sensitive to notch stress, or for plated or surface-hardened materials whose plating must be retained. The mildest form of mechanical pre-treatment and removal of oxide layers is erosion by a glass fibre eraser (otherwise used for China ink drawing). Another method is to use a typewriter eraser, an India rubber filled with glass particles. Finally there are chemical methods, which are dealt with in section "Pickling".

- **Marking**

Use marks to indicate the exact position of the gage. Foil strain gages have corresponding marks for the centre axes of the measuring grid. Drawing needles or scribes are not recommended for marking because even slight damage to the surface might impair or even break the specimen. A dry (empty) ballpoint pen is much better, since the ball leaves a clearly visible line but will not damage or leave notches in the surface. If ink is still in the ballpoint pen, this must be removed with a solvent (e.g. RMS1) after the line has been drawn.

Soft materials like aluminium may be marked with a sharp pencil, the necessary hardness (grade 4H to 6H) should be checked on a separate piece of material. Lines still need to be visible after final cleaning, but no grooves should be created.

- **Final cleaning**

The efficiency of the bonding forces described in section 2.1 decreases with the third to sixth power of the distance. Therefore, these forces should be limited to molecular layers. For that reason, very careful final cleaning is required. Even the thinnest layers of grease will considerably impair the effectiveness of the bonding forces or will even neutralize them. Silicon grease or oil is most difficult to remove. This is widely used in cosmetics (hand lotions, etc.) and the installation technician should therefore avoid them.

Vapour degreasing is advisable if equipment is available and the specimens lend themselves to it. Usually degreasing is done by rinsing with grease solvents (e.g. RMS1). Observe all labour safety regulations! If flammable solvents are used, remove all ignition sources and do not smoke! Proper ventilation is essential for health reasons, to avoid formation of explosive gas-air mixtures, and to prevent a build up of solvent vapours heavier than air, which might lead to suffocation.

The organic solvents, which are preferred for final cleaning, are commercially available sometimes in two degrees of purity:

Technically pure means: free from dirt particles;

Chemically pure (also indicated by “pro analysi” or “p.a.”) means: also free from soluble impurities as far as possible .

Chemically pure solvent should be used for cleaning strain gage installation points.

With **RMS1**, HBM offers a solvent combination that is chemically pure, environmentally compatible and that can remove all impurities.

Generic or trade name	Other chemical name	Chemical formula [summation formula]	MAK-value ¹⁾		Remarks
			ppm	mg m ³	
RMS 1	Acetone and 2-Propanol	CH ₃ ·CO·CH ₃ · [C ₄ H ₈ O] und CH ₃ ·CH(OH)·CH ₃ [C ₃ H ₈ O]	400	980	Inflammable
Methyl-ethyl-ketone	Butanon-(2)	CH ₃ ·CH ₂ ·CO·CH ₃ [C ₄ H ₈ O]	200	590	Inflammable
Acetone	Acetone	CH ₃ ·CO·CH ₃ [C ₄ H ₈ O]	500	1200	Inflammable
Isopropylalcohol	Isopropanol	CH ₃ ·CH(OH)·CH ₃ [C ₃ H ₈ O]	400	980	Inflammable
Ethylalcohol	Ethanol	CH ₃ ·CH ₂ ·OH [C ₂ H ₆ O]	1000	1900	Inflammable
Ethylacetate	Acetic acid-ethylester	CH ₃ ·CO ₂ ·C ₂ H ₅ [C ₄ H ₈ O ₂]	400	1400	Inflammable
Toluol	Methyl benzol	C ₆ H ₅ ·CH ₃ [C ₇ H ₈]	50	190	Noxious; Inflammable
Pure benzine	-	-	*	*	Inflammable; * no official figures available

¹⁾ MAK values according to standards

MAK means: maximum allowable concentration of the work place.

Table 2.3-4: Popular solvents for cleaning and degreasing of installation areas.

During final cleaning, the following should be observed:

- Wash hands, if necessary, between each step.
- Do not use hand lotions, only grease-free ointments (see section 2.3.6).
- Never use solvent directly from the bottle. Pour a small amount into a clean vessel (petri dish) and then use from here. Never put remainder back into bottle, it is better to discard the excess.
- Use cleaning materials that are free from grease and lint. Cellulose pads are well-proven. Use each pad once only! Paper tissues are only suitable if they do not contain soluble particles!
- Do not put your fingers into the solvent since grease from the skin will be dissolved, which pollutes the solvent. Use rubber gloves or fingers, tweezers.
- First clean a relatively larger area, then a smaller area to prevent dirt penetrating from the edges to the application spot. Continue cleaning until the pad no longer shows traces of dirt. Finally use fresh pads for only one stroke from the centre to the outer areas, in at least two directions. Use tweezers or clean tissue paper to remove any residual lint, **do not blow off!**
- If humidity condenses on the bonding surface due to cooling from evaporation of solvent, dry again using a hot air gun.
- Do not touch clean surfaces with the fingers!

Note 2.3-2:

Do not use solvents containing chlorine on light metals, e.g. aluminium or titanium alloys. These alloys sometimes bleed oily substances onto the surface, which continues even after thorough cleaning and degreasing. It is assumed that this “bleeding” comes from lubricants rolled into the surface of the metals. Countermeasure: clean, heat, clean again, etc. until the bonding area stays clean. However, later loosening of the bond cannot be excluded.

- Pickling

Chemical pre-treatment of the bonding areas by pickling is only seldom applied in strain gage technology owing to the relatively large effort required. Nevertheless, it is mentioned here for the sake of completeness.

Pickling may be used after, or instead of, the mechanical treatment. Apart from the activation of interfacial forces, it produces a very fine roughening. This microscopic roughness is advantageous as the stability of the specimen is retained. A special advantage is the fact that very delicate objects do not bend or twist. Pickling produces a very good and uniform bond strength of the glue line.

Pickling should be carried out immediately before the cementing. Special attention should be given to neutralizing, rinsing and drying of the bonding areas. Please refer to [5] for further details of methods for metallic materials. Pickling of aluminium alloys tends to produce a noticeable improvement of the bond strength when compared with other treatments, but this is not the case for steel [6].

2.3.2 Preparation of bonding surface on non-metals

- Concrete

The preparation of the bonding surface on concrete using rapid adhesive X60 is, in general, simpler than on metals, irrespective of whether the concrete was cast with oiled or dry mould forms. In the first case, the oil-soaked layer is removed with a grinder. Degreasing with solvents is not recommended, since the solvents together with the oil only penetrate deeper into the concrete. For dry covering, only the cement slurry is removed up to the solid concrete. Also in the case of dry mould form, grinding is recommended in order to obtain even surfaces. Grinding dust is blown away using an air pump or with oil- and water-free compressed air. Pores are completely filled with X60. Bonding areas shall only be flattened. After about 30 minutes, a thin aluminium barrier foil or, if applicable, the strain gage may be cemented. (see note 2.3-3.)

Note 2.3-3:

Concrete requires a cement with very good pore filling properties, which cures even under ambient humidity. For this, the rapid adhesive X60 is well proven.

The non-homogeneous structure of concrete requires strain gages with long grids, which provide an average strain value. Further details are given in [2, volume 73004e].

Direct bonding of the gages is only recommended on dry parts. In the presence of residual moisture, it is advisable to cement first a thin aluminium foil as a barrier, then the strain gage.

Absolute measurements with reference to zero point are only feasible if the concrete specimen is completely dry or the moisture content remains stable during the measurement. Under varying humidity, concrete will shrink or swell. Therefore, absolute measurements are only feasible over a long period of time if there is a similar unloaded specimen for compensation. The rules for installing strain gages to metals also apply if the reinforcement of concrete is gaged.

Note 2.3-4:

One should also consider using clamp-on strain transducers, e.g. the type DD1 [9] or SLB 700A, for measurements on concrete.

- Glass (silicate glass), glazed porcelain, enamel
With X60, Z70 and EP250 it is possible to bond immediately to the degreased surface. Roughening or other preparations are not necessary. X60 can be removed mechanically or by dissolving with Methyl-Ethyl-Ketone (MEK) or acetone; Z70 and EP250 may be scratched off polished glass. In the same way, strain gages may be installed on glazed or enamelled materials or ground surfaces of earthenware and the like [10].

- Plastics

are roughly divided into two groups which require different pre-treatment:

- a) soluble plastics, which are easy to cement, and
- b) non-soluble (mostly non-polar) plastics, which are difficult or impossible to cement without pre-treatment.

Group a) comprises chiefly plastics of amorphous structure, e.g. polystyrene (PS) and modifications, polyvinyl-chloride (PVC), polycarbonate (PC), cellulose-acetobutyrate (CAB), polymethyl-methacrylate (PMMA).

Group b) comprises part-crystalline plastics, e.g. high density poly-ethylene (HDPE), low density poly-ethylene (LDPE), polypropylene (PP), poly-oxymethylene (POM), polyamide (PA).

The physical or chemical treatments used on plastics serve to activate the molecular structure of the surface.

The treatment of soluble plastics aims to remove all production additives, especially separation means like silicones or talc, lubricants like stearates, dirt from the surface and moulding skins on injection moulded parts.

Organic solvents are used for degreasing, e.g. organic sulphonates or alkaline phosphates. Other suitable methods are scraping with glass pieces and/or roughening with emery grade 220 to 360. On non-soluble plastics, the measures detailed above are sometimes successful and sufficient bonding strength is obtained. In most cases, however, a more rigorous treatment, which changes the surface structure of the plastics and gives good bonding capabilities, will be necessary. Comprehensive advice on the pre-treatment of plastics is given in [11, 12].

Care should be taken when using solvents for the treatment of plastics, since their action could cause swelling or stress corrosion. Pure benzine (but not for polystyrene) and isopropylalcohol may be considered safe on the whole, especially in view of the short contact time. In all critical

cases, trials should be conducted as it is extremely difficult to predict bonding performance for all materials because of the immense number of modified plastic materials.

In this context the paper [13] is important and gives a very comprehensive report concerning the installation of strain gages on plastics and related problems.

Note 2.3-5:

List of some successful installations on various plastics, after simple preparations:

- (1) High-density polyethylene (HDPE) structural foam. Bonding with rapid adhesive Z70.
Preparation: Bonding area roughened with emery grade 320, dust carefully removed, no solvent.
Bond strength sufficient for $\epsilon = 2$ cm/m.
- (2) Polypropylene (PP). Bonding with rapid adhesive X60 or Z70.
Preparation as in 1) above. Strain level achieved: $\epsilon = 5 \dots 6$ cm/m.
- (3) Polyoxymethylene (POM), polyacetal. With quick curing cement Z70.
Preparation: dry roughening with emery grade 220. Very good bond strength.
- (4) Phenolic resins, cresolic resins, melamine resins and laminates thereof. Bonding with X60.
Preparation: Dry roughening with emery grade 220.
- (5) Polymethyl-methacrylate (PMMA), acryl. Bonding with X60 or Z70.
Preparation: degreasing only. Very good bonding.
- (6) Polyvinyl-chloride (PVC) without softener. Bonding with X60 or Z70.
Preparation: degreasing only. Very good bonding.
- (7) Polycarbonate (PC). Bonding with X60 or Z70.
Preparation: dry roughening with emery grade 220 to 320. Good bending.
- (8) Polyester resins (fully cured, also glass fibre filled and carbon fibre filled). Bonding with X60 or Z70.
Preparation as in 7) above. Good bonding.
- (9) Epoxy resin (EP). Bonding with X60 or Z70.
Preparation as in 7) above. Very good bonding.
- (10) Polystyrene (PS). Bonding with Z70.
Preparation as in 7) above. Very good bonding.

Note 2.3-6:

Some methods for the pre-treatment of poly-olefines (3, 5, 11, 12).

- (1) High density polyethylene (HDPE) alternative methods:
 - a) "Ironing" of strain gages using phenolic carrier with heated tool.
 - b) Melt fine surface layer of PE with soft gas flame. PE will become bondable.
 - c) Etch surface of PE with chromium sulphuric acid, rinse with water [3].
 - d) Etch surface of PE by the "Pickling method" according to [5] (sulphuric acid-natriumdichromat method, short symbol A) rinse with water, then with desalinated water. This method is also suitable for other olefines [3].

e) Etch surface of the PE with a mordant to following:

50.5 cm ³	concentrated sulphuric acid,
4.1 cm ³	water
2.5 g	potassium dichromate

Roughen surface with emery and paste on mordant heated to 90⁰C, allow to react, and rinse with water. Cement used is X60.

This method of etching should only be used by persons who have sufficient experience with acids and chemical agents.

(2) Polyamides (and other plastics) are made bondable by treating with hydrogen-peroxide [3].

- Wood

Wood may be cemented with the quick curing cement X60 after dry grinding with glass or flint paper.

Note 2.3-7:

Wood is a non-homogeneous, anisotropic and porous material. These properties, which are dominant in conifer wood for building, make strain gage measurements very difficult. Apart from extreme differences of the elasticity characteristics due to the structure of wood, there are changes as a result of the penetration of the cement into surface layers. There are good prospects for such measurements where calibration of the measurement point is possible and if a sufficiently long gage is used for averaging of the partial strain as on concrete.

- Rubber

After degreasing with one of the solvents listed in table 2.3-4, rubber may be cemented with the fast curing cements X60 or Z70. Light roughening with emery might be necessary in some cases.

Note 2.3-8:

Strain measurements on rubber are problematic in view of strain suppression from the reaction force (strain stiffness) of the gage. The softer the rubber, the greater this effect. Furthermore, it cannot be concluded from the large extensibility of some strain gage types that they are suited for the measurement of large strain on rubber. They can undergo large extensibility only once (or several times). Strain transducers with low reaction forces are better for such installations, e. g. [9]. See also [14].

2.3.3 Strain gage installations in medicine

In medical research, strain gage techniques have been mainly used in surgery, orthopaedics and dental surgery.

Provided that the use of strain gages in connection with metallic or non-metallic instruments is intended, e.g. measurements on osteosynthetic plates, prostheses, etc., the same technical installation technologies are shown as in the technical area. When using on or in living organisms make sure that there is no possibility of toxic or allergic reactions as a result of contact with the installation material. For implantations, select materials that are compatible with tissue and which are resistant for longer periods of time to ferment. The information accessible to the author shows that the following materials have been used successfully for in-vivo-installations:

- for degreasing: Ether
- for gluing: Hystoacryl® blue (produced by: B. Braun-Dexon GmbH, 3508 Melsungen)
- strain gages: “Y” series with polyimide carrier
- for wiring: leads with PTFE (Teflon®) or NDPE insulation.
- for covering agent: ABM 75 or from covering agent ABM 75 the ABM 75 putty alone, further covered with PTFE foil.

A comprehensive description of the installation technique on bones is given in [15]. For further applications of strain gages in the medical field, see [16 to 19].

For installations on dead organisms, rapid adhesive Z70 can be used for gluing and for protecting the silicon rubber SG 250. As the physiological properties of both materials are unknown, it is not recommended that they are used in vivo.

Installations on soft parts are less successful due to the restoring force of the strain gage, unless one limits oneself to the purely qualitative display of events, e.g. muscle reflexes.

2.3.4 Preparation of the strain gages

- Cleaning

HBM strain gages are delivered ready for use and do not require special treatment. However, if the bonding side of the gage was touched with fingers or polluted in some other way, cleaning with a solvent on a Q-tip is recommended. For strain gages with phenolic resin carrier (G series) use one of the solvents listed in table 2.3-4. For strain gages with polyimide carrier only RMS1 or pure benzine are suitable.

- Adaptation to the specimen contour

The flexibility of the gage mainly depends on the properties of the carrier, and to a small extent also on other components, e.g. integral solder terminals. The table 2.3-5 summarises the smallest bend radii for all strain gage types, which can be achieved without special treatment of the strain gages. The polyimide carrier of Y series strain gages is so flexible that they can be installed even on the smallest radii without suffering damage. Other carriers are more brittle and will break when bent to small radii, however, they may be prepared easily for the installation on even smaller radii by pre-forming. This is done with a soldering station with controlled

temperature where the bit is replaced by a pin made from copper, brass, aluminium or steel with a diameter to suit the required radius (see fig. 2.3-2).



Strain gage	Series designation	Smallest bending radius	
		Lengthwise mm	Across mm
Carrier material			
Polyimide resin (Y- and G-series)	LY11; LY21	< 1	< 1
	LY61 in area of solder tabs	< 1 2	< 1 2
Phenolic resin glass fibre filled (G- and K-series)	LG11; LG21	3	3
	XG11; XG21	3	3

Table 2.3-5: Smallest bending radii for gages without pre-forming

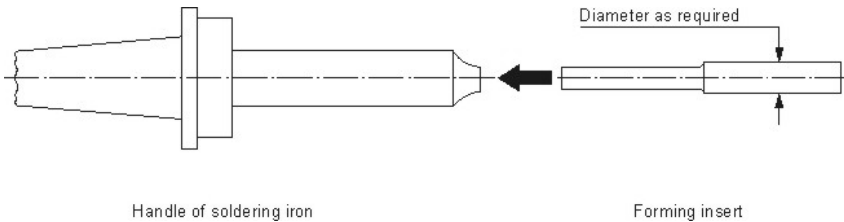

Fig. 2.3.2: Auxiliary tool for forming of strain gages to fit small radii (only necessary for strain gages with phenolic resin carrier).

Then proceed as follows:

- Place a high temperature self-adhesive tape on the back of the gage (see fig. 2.3-3), e.g. Permacel® tape supplied with the EP250 and EP310 cement packages. Masking is according to sketch a) or b) whether the bending is parallel with or across the gage. Cut adhesive tape along the edges to be bent, otherwise there will be problems when removing the forming tool.
- Fix short end of the adhesive tape to the cold forming insert, see sketch c), so that the bending axis is as desired: straight, cross, or slanted.

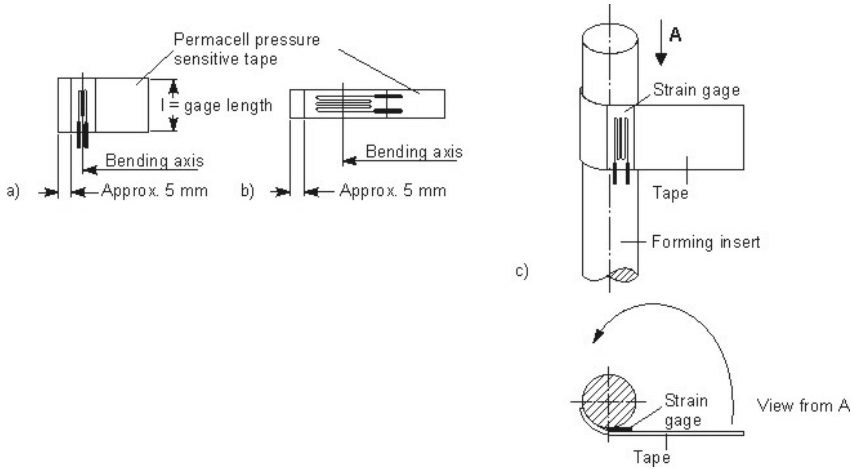

Fig. 2.3-3: Forming method for brittle strain gages to fit small radii

- Set temperature control to target temperature, switch on and wait until target temperature is reached (indicated by control lamp). For gages of the K- and G-series, the forming temperature is between 200... 230°C.
- Hold free end of tape and guide slowly around forming insert so that gage smoothly follows the contour (see sketch c) view A). Stick end of tape, switch off current and allow to cool.
- Carefully peel off tape, first from one end to the gage, then from the other end. Do not peel off completely from one end because the gage may break if radii are small and the gage is completely flattened again. Use the tape for fixing the gage position as described in section 2.3.5 and remove only after installation of the gage.
- Application accessories and solder terminals (see also section 3.1.5)

Strain gages of the LY 61 series (fig. 2.3-4, sketch a) have integral solder terminals, which may be used for direct soldering of the measurement leads. Strain gages of the LY 41 series (fig. 2.3-4, sketch b) permit direct soldering of thin leads but in most cases it is advisable to use separate solder terminals in the same way as with gages having ribbon leads (fig. 2.3-4, sketch c). This facilitates faultless solder connections and protects the leads from tension forces of the cables.

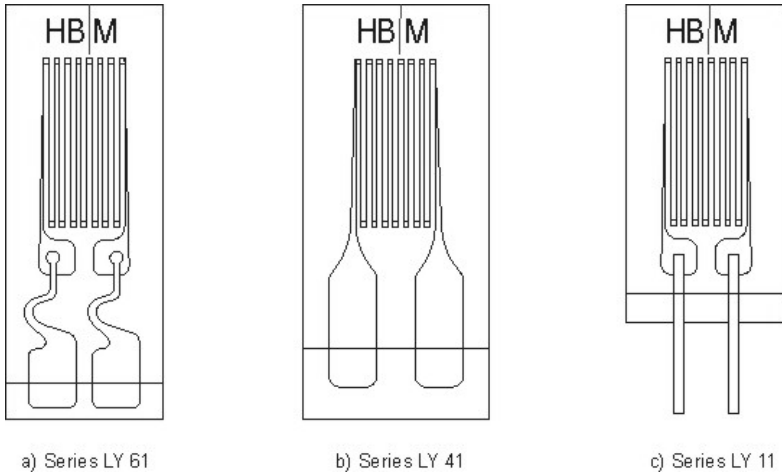

Fig. 2.3-4: Types of strain gage connections

- a) Ni-coated solder terminals
- b) Solder tabs
- c) Lead wires

The auxiliary techniques 1 and 2 described below allow installation of strain gages with minimum effort. The advantage lies in the fact that more difficult work can be carried out in the laboratory under favourable conditions while, on-site, work is minimized. Consequently, the installation is quicker and the resulting measurement more reliable.

Auxiliary technique 1

Strain gages as in fig. 2.3-4, sketch a, might have an oxide layer on the Nickel coated solder terminals, which could make the soldering of the leads later on more difficult. Therefore, it is advisable to remove the oxide layer using a glass fibre eraser. Then apply a tape to the gage, as shown in fig. 2.3-5. The tape should cover the strain gage terminals but leave 3 sides and all corners free.

The gage prepared in that way is glued onto a piece of cellophane, glass or Teflon foil and kept ready for installation.

Strain gages of the LY 41 series (fig. 2.3-4 c) are prepared in the same way if thin wires are to be soldered directly. In the case of heavier measurement cables, it is advisable to use the auxiliary technique 2.

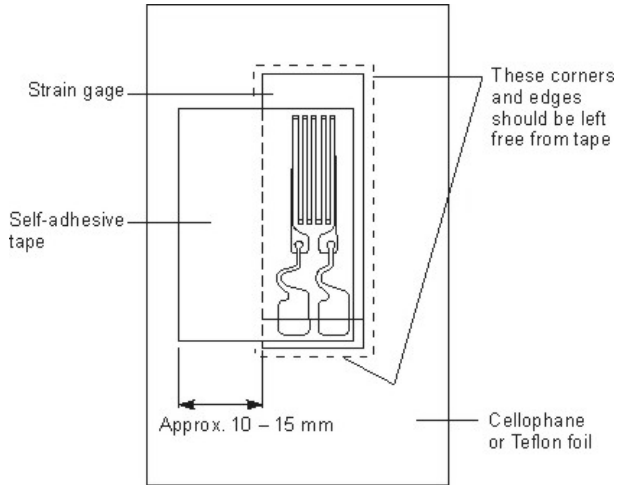

Fig. 2.3-5: Auxiliary technique 1 for the installation of a strain gage

Auxiliary technique 2

Strain gages as in fig. 2.3-4, sketch c (if suitable also gages according to sketch b), are appropriately combined with solder terminals (see note 2.3-9), which give good anchoring of the cables.

- a)
 - Cut off a pair of solder terminals from a terminal strip (the rim should be at least 0.5 mm wide), see fig. 2.3-6, sketch a).
 - Clean fingerprints off the strain gage and terminal, e.g. with "RMS 1" and then handle only with tweezers.

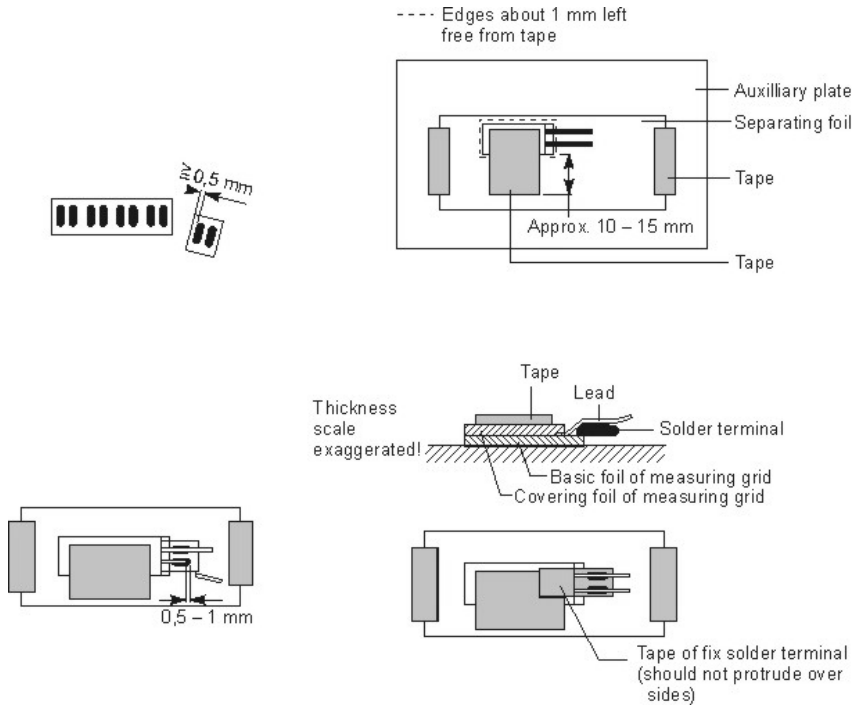

Fig. 2.3-6: Auxiliary technique 2 for the installation of a strain gage

- a) Cut off a pair of terminals
- b) Prepare auxiliary support plate and fix the strain gage with tape
- c) Position the terminals and shorten the gage leads
- d) Fix the terminals with tape

Note 2.3-9:

Solder terminals are offered in various sizes and versions; technical details are given in the relevant leaflets. Selection criteria are:

- a) Distance between the strain gage connections
- b) Available space on the specimen.
- c) Temperature stability and fixing method.

The temperature range of cemented solder terminals is mostly defined or limited by the cement used.

- b)
 - To facilitate the next step, use a clean glass or auxiliary support plate from sheet metal or plastic (approximate size 10 cm x 10 cm), cover with separating cellophane or Teflon foil (approx. size 3 cm x 6 cm) and fix some tape on the edge to prevent slipping. This support shall be used for the next steps.
 - Put a tape on the upper side of the gage, which protrudes 10 to 15 mm over the gage itself. The other three edges of the gage are left free! See fig. 2.3-6, sketch b. Fasten gage to the separation foil by means of the projecting tape.
- c)
 - Insert solder terminals between base foil of the gage grid and the leads, see, fig. 2.3-6, sketch c and shorten connection tapes.
- d)
 - Join gage and terminals with tape, covering the metal pads completely with the tape, see fig. 2.3-6, sketch d. Remove the gage and the separating foil from auxiliary support and keep ready for installation.

Note 2.3-10:

If hot curing cement is applied, use heat-resistant adhesive tape made from polyimide, e.g. HBM's "1-Klebeband". The appropriate tape is supplied with HBM hot curing cement.

2.3.5 Bonding process

Instructions for use are included in every package of cement. These should be strictly observed. As the instructions contain exact and comprehensive details on the handling and installation of the strain gage adhesive; these are not repeated here. The following explanations give further hints, which facilitate the installation work and help prevent mistakes. It is, in fact, very simple to transfer the gage to the specimen and align the gage properly.

- Use tweezers to take strain gage (prepared according to section 2.3.4) out of the protection foil (Caution! Hold tape only, not gage!).
- Align gage at the installation position, which has been prepared according to section 2.3.2, in such a way that the gage markings are aligned with the position markings. Then press on the tape, see fig. 2.3-7, to produce a hinge-like connection between gage and specimen.

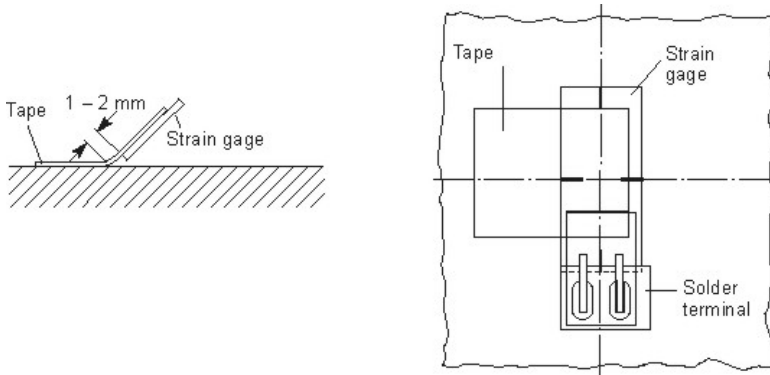

Fig. 2.3-7: Fixing the strain gage to the measurement object

- In addition, a mask may be produced from tape around the gage, leaving a free space of about 3 to 5 mm. This is recommended particularly when using rapid adhesive X60 because, when the gage is pressed down, surplus cement is transferred onto the mask and is easily removed after curing.

The following steps are carried out according to the instructions for use of the relevant cement. The following hints on handling certain cements are given, as experience has shown that instructions are often not followed properly.

Rapid adhesive X60 should have a consistency like a paste, not too stiff, to give a cement layer that is not too thick. It should also not be too liquid, otherwise air bubbles may form under the gage. Such air bubbles represent a severe installation defect. Another trick is recommended which will prevent them, see fig. 2.3-8 for further details.

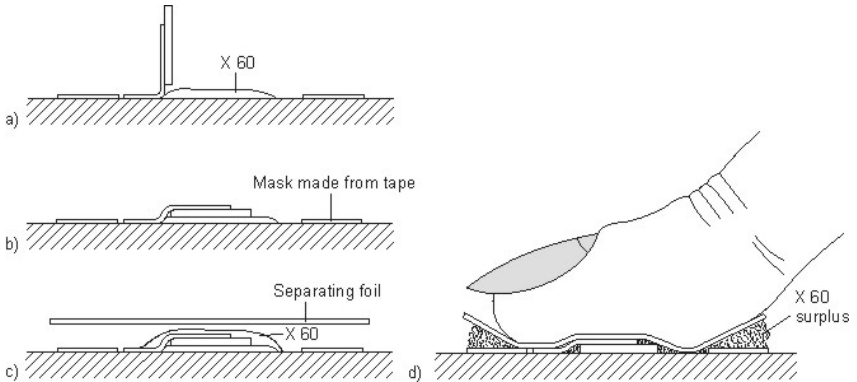

Fig. 2.3-8: Strain gage application with rapid adhesive X60

- a) Bend gage upwards, apply adhesive generously with spatula
- b) Bend gage down and press lightly
- c) Paste adhesive onto the gage and cover with separating foil
- d) Press out surplus of adhesive. See also note 2 3-11.

Note 2.3-11:

The best tool for pressing on the gage when applying with cold curing adhesives is the thumb of the installation technician. It surpasses all other auxiliary tools when its inherent advantage of feeling, is properly used.

With X60, the surplus adhesive is first carefully pressed outwards, by rolling the fingertip onto the mask of tape. Do not push or pull to avoid misaligning the gage. Squeeze out the rest with increasing pressure until finally a very thin, almost translucent glue line is obtained. Be sure to always roll the finger. Do not push, pull or tear the gage!

The adhesive layer over the gage is sucked onto the separating foil, thus preventing air bubbles forming. It is, therefore, no longer necessary to press the gage during the curing process of the adhesive. If air bubbles occur in spite of these precautions, the adhesive was too runny (too much fluid used).

After some minutes (depending on the temperature) the separating foil can easily be removed. It is better to remove the mask with the surplus of adhesive immediately because this is more easily done before final hardening of the adhesive. At the same time auxiliary adhesive tape is removed from the strain gage, by carefully and slowly peeling it off with tweezers.

Cyanoacrylate Z70 cures within seconds if spread very thinly and isolated from the air with a Teflon separating foil and pressed on using moderate pressure.

Polymerization of Z70 occurs by the catalytic reaction of moisture absorbed from the air. The most favourable conditions are given by a relative humidity between 40% and 70%. Please ensure that limit values 30% and 80% r.h. are not exceeded.

The installation is really quite simple and easy.

- a) Bend gage upwards,
- b) Put one small drop of cement onto the specimen and immediately spread into a thin, even layer using the Teflon strip supplied with the package (do not exert any pressure).
- c) Bend down gage, cover immediately with Teflon separating foil and press evenly for about 20 sec. See also note 2.3-12. For overhead work, the cement drop is put onto the Teflon strip and then spread on the installation area.
- d) Carefully peel off the auxiliary adhesive tape with tweezers.

Note 2.3-12:

Each interruption of the curing procedure of Z70 cyanoacrylate is detrimental. It is important that pressure is applied on the gage **immediately** and **evenly** across the **whole** area. The pressure must be **constant** until the adhesive hardens. A frequent mistake is that pressure is applied unevenly on the gage and then corrective action is attempted by moving pressure over the wider gage area. In this case, the cement may cure only partly when pressed on for a short period and cannot cure completely when pressed on the next time. For larger gages, which cannot be completely covered with the thumb, a soft rubber cushion is useful. If necessary, the cushion may be adapted to the specimen contour.

Another fault is working too slowly so that the cement is completely or partly dry before the gage is pressed on, thus making a satisfactory bond impossible. This is particularly common in hot weather.

Also the chemical state of the work piece surfaces can influence the hardening of the adhesive: materials with basic reaction speed up hardening, materials with acid reaction slow down or even prevent hardening. The latter case may be considered a rare exception. In most cases, inadequate curing is due to the layer of adhesive being too thick. Should there be an acid reaction, then hardening may be forced by adding the accelerator BCY 01. In that case, the acid side is covered with a thin layer of the neutralizer, which is allowed to dry. The adhesive is then applied to the gage and the gage is pressed on. Shock curing now starts within a few seconds. However, a residual stress will remain in the adhesive layer, which may impair the extensibility or the stability of the bond over long periods of time. Therefore, neutralizer should only be used if necessary.

Epoxy adhesives EP250 and EP310S require elevated temperatures and pressure during hardening. For stress analysis measurements, the pressure should be 1 to 5 bar. For precision measurements or for the production of transducers or in cases where the measurement point is subject to high hydrostatic pressure, a curing pressure of between 10 to 15 bar should be used.

Spring-loaded clamps are best to provide the damping pressure. Clamps should be matched to the shape of the specimen. Fig. 2.3-9 shows a few examples that can be easily made.

Springs are necessary to produce a well-defined clamping pressure and then to keep the pressure even when the pad, which covers the gage, yields under the influence of the heat. In order to avoid uneven bonding of the gage, a cushion should be placed between the pressure jig and the gage. A pad about 2 mm thick made from several layers of blotting paper is the cheapest and best material. Compared with rubber its advantage is that this cushion is flexible in the direction of the pressure, thus equalizing differences of thickness without expanding sideways and deforming the gage.

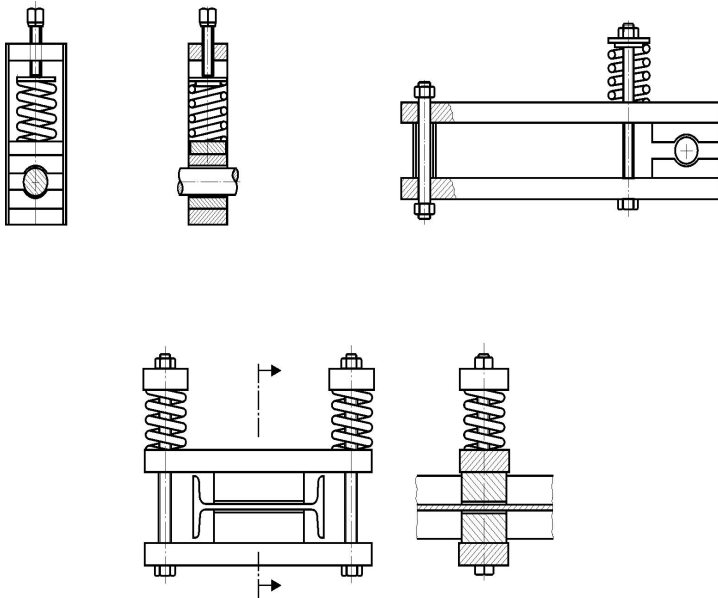

Fig. 2.3-9: Some examples of spring-loaded jigs for strain gage applications with hot curing cements

Note 2.3-13:

Example for determining the clamping pressure.

The spring rate of the spring used is assumed as $c = 100 \text{ N/mm}$.

The spring rate, also called spring constant, is the force F required to compress the spring by a spring displacement of $s = 1 \text{ mm}$.

$$c = \frac{F}{s}$$

On light springs it is determined by loading with weights, on heavier springs by means of a testing machine. A weight with a mass of 1 kg produces a weight force of about 10 Newton (N). In this example, the spring used is depressed by a weight of 10 kg with its weight force of 100 N, deflecting it by 1 mm.

The area under pressure is assumed to be $3 \text{ cm} \times 5 \text{ cm} = 15 \text{ cm}^2$. This refers to the total area under pressure, not only the gage surface.

The required clamping pressure is $5 \text{ bar} = 50 \text{ N/cm}^2$.

The clamping screw has a pitch of $s = 1.5 \text{ mm/tum}$.

The required force F is:

$$F = 15\text{cm}^2 \cdot 5\text{bar} = 15\text{cm}^2 \cdot 50 \frac{\text{N}}{\text{cm}^2} = 750\text{N}$$

With a screw pitch of $s = 1.5$ mm and a spring rate of $c = 100$ N/mm the increase of force ΔF per turn is:

$$\Delta F = \frac{s}{\text{Umdr.}} \cdot c = 1,5 \frac{\text{mm}}{\text{Umdr.}} \cdot 100 \frac{\text{N}}{\text{mm}} = 150\text{N} / \text{Umdrehung}$$

The required force F 750 N is obtained with:

$$\frac{F}{\Delta F} = \frac{750\text{N}}{150\text{N} / \text{Umdr.}} = 5 \text{ Umdrehungen der Spindel}$$

Epoxy adhesive X280 offers high temperature stability despite the possibility of **cold curing**.

Adjust the strain gage onto the work piece using heat-resistant tape.

A sufficient amount of adhesive should be applied onto the strain gage and the work piece. Use one of the wooden sticks provided or a spatula. Then press slightly to fix the strain gage.

Now put the neoprene rubber onto the Teflon foil provided and cover the installation point with it. Make sure that the piece of Teflon is larger than the piece of rubber to prevent the rubber from sticking to the work piece.

Now put a metal plate onto the installation point and load it with a minimum force of $5\text{N}/\text{cm}^2$. Use weights, spring pressure, magnets or similar to generate this force.

The hardening time for X280 is 8 hours at room temperature. Heating can be used to reduce the hardening time: at 65°C , hardening time will be 2 hours, at 95°C 1 hour. The adhesive needs temperatures of 10°C or more for hardening; at 10°C the hardening time is 36 hours.

If in doubt, apply a small drop of adhesive beside the installation point to test the hardening state.

2.3.6 Precautions

The following hints should not cause unnecessary panic; from many years' experience we can say that there is no reason for that. It is, however, a warning against excessive carelessness and its consequences.

When roughening beryllium and its alloys it is strongly recommended that a filter mask be used. Beryllium is proven to be a carcinogen [20].

When installing gages, cleanliness should be painstakingly observed. This applies not only to the installation area and the strain gage but also to hands. Some people have allergic reactions when handling the solvents and chemicals associated with strain gage work. Therefore, direct contact with the skin should be avoided whenever possible.

As an allergic disposition may be unknown, always wash the hands thoroughly with lukewarm water and neutral soap as soon as the cementing work is completed.

Z70 as a cyanoacrylate adhesive is supplied by HBM in small plastic phials with sealed plastic nozzle. During transport this nozzle usually fills with adhesive. When cutting off the end of the nozzle, the adhesive may squirt out due to the slight overpressure in the container. When opening

the phial, hold it so that cement does not squirt into your face or onto anyone else nearby. If a drop of Z70 gets into the eye, it will cure immediately due to the tear liquid. This polymerisation reaction will set free some heat, which will slightly irritate the cornea. During the first minutes, this will cause short sharp pain. Rinse the eye immediately with lukewarm water or with boracic lotion. Then consult a doctor. Experience shows that the cornea is regenerated within a few days and there will be no permanent damage to eyesight. Z70 cannot be removed from the clothing.

Hand creams or lotions are often used to protect the skin (especially by people who often use solvents). Many lotions contain silicon grease. Silicon grease will spread over any items that come into contact with it, e.g. tools, which then transport it on to the measurement areas. It is practically invisible and very difficult to remove. Even molecular layers lead to reduced adhesion of the cements. It is, therefore, advisable not to use such lotions. A good protective ointment, free of fat is recommended. Consult your chemist who will help you.

Any work area designed for strain gage bonding must ensure that there is good ventilation in order to prevent inhalation of solvent or adhesive fumes. Observe the safety data sheets as well as relevant rules for the prevention of accidents. Do not smoke while working with such adhesives.

3 Connecting the cables

The best and most commonly used method of the electrical connection between the strain gage and the measurement lead (measurement cable) is soldering. This is dealt with at length in the following chapters. Similarly excellent connections are obtained by crimping. Clamp connections may result in zero point shifts because of variation of the contact resistance. Plug connectors are even more critical and only first class quality types with gold-plated contact elements have proven to be sufficient and then only as long as their function is not hindered by dirt contamination. In principle, it can be said that normal high current connection techniques are insufficient because of the very low measurement voltages and currents used in strain gage work.

3.1 Soldering tools, soldering materials, wiring

3.1.1 Soldering irons

It is recommended to use temperature controlled low voltage irons, which are supplied via a control unit from the mains. Models with sensitive, continuous electronic control and high heating power (approx. 50 W) are preferred since withdrawal of heat during soldering is immediately balanced. The temperature control range of commercially available soldering stations lies between 120 and 400°C, which is sufficient for all soft solders used with strain gages.

3.1.2 Bits for the soldering iron

The quality of reliable solder joints is mainly determined by the selection of the correct solder bit for the installation. A point type bit, like a pencil, is not suitable (see fig. 3.1-1a) since heat conduction from the bit onto the solder point is insufficient and the molten solder is sucked away from the point, leading to a deficit at the solder point. A small area matching the size of the solder point, is recommended (see fig. 3.1-1 b, c and d). The question of straight or hooked ends depends only on the possibility of access to the solder point.

Coated bits take up solder only at certain spots thereby concentrating the molten solder to the actual soldering spot. Coating also prevents oxidation of the bit.

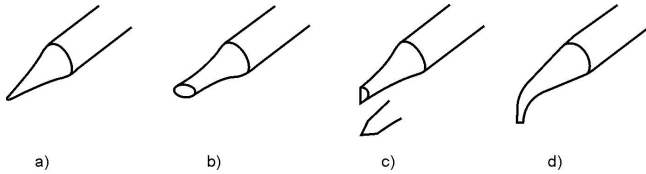

Fig 3 1-1 Some shapes of soldering bits

- a) not suited too sharp
- b) single-sided area } area matched to solder spot size
- c) double-sided area
- d) curved form

3.1.3 Solders (soft solders)

Numerous soft solders are commercially available. Depending on alloy contents and composition they are optimally suitable for certain requirements. For strain gage installations, good wetting and flow properties are valued, apart from a melting point matching the conditions of use.

The service temperature should not rise higher than 30 K below the melting temperature to ensure the mechanical stability of the solder joint.

Note 3.1-1:

Sometimes it is noticed that tin solders will undergo a phase transformation at low temperatures, decomposing from normal white tin (β -phase) into grey, powdery tin (α -phase). This phenomenon called "tin plague" is only observed on tin of highest purity and only under most unfavourable conditions. Normal tin solder alloys composed of or contaminated with lead, bismuth, copper, arsenic, iron, etc. never show such effects, even after 10 years of storage at -40°C . A comprehensive report is given in (21).

Small amounts of copper prevent corrosion of the soldering bit (copper protective solder).

Solders with higher fatigue resistance are beneficial for dynamic continuous load.

Table 3.1-1 lists some common soft solders. Further information may be taken from DIN 1707 or the leaflets from solder manufacturers.

Solder description according to DIN EN 29453	Alloying constituents %			Melting range °C	Recommended soldering peak temperature °C	Remarks
	Sn	Ag	In			
Sn 96.5 Ag 3.5 with flux C3 (2.5% or 3.4%)	98.5	3.5		221° C	300	e.g. Elsold sold through JL Goslar

Table 3.1-1: Soft solders

Note 3.1-2:

In the high temperature range, welded connections should be preferred. Brazing shall only be used with extreme caution because of the aggressive fluxes!

3.1.4 Fluxes

Fluxes serve to remove oxide layers from the solder spot and prevent fresh oxidation during the solder process. This is a prerequisite for perfect connection between the soldering parts. The flux should be selected according to the type of soldering (e.g. soft soldering), the nature of the materials to be soldered (e.g. heavy metals), and the kind of soldering connection (e.g. electrical circuitry).

Highly corrosive fluxes are convenient because lightly cleaned solder points may also be soldered. The disadvantage is that residue will inevitably corrode further and greatly reduce the insulation properties of insulation paths. In any case, they are not suitable for soldering electrical circuits. Never use solder grease!

Non-corrosive fluxes are manufactured on the basis of natural or modified natural resins. The best-known resin is colophony (rosin flux). It is used as the core of solder wires or dissolved in methylated spirit as a liquid. These “soft” fluxes require thorough cleaning and making the solder point bright immediately before soldering. They are most suitable for strain gage installations.

Note 3.1-3:

The flux core of many solder wires may be corrosive or non-corrosive. Before using it, ascertain the nature of the flux. The German Standard DIN EN 1045 “Fluxes for soldering metallic materials” gives information about various fluxes.

Fluxes with type designation F-SW 31 and F-SW 32 will not leave corroding residue. The name “acid-free flux” is misleading and not appropriate. It must not be used according to DIN EN 1045 .

3.1.5 Solder terminals

The task of solder terminals and their use was already touched on in section 2.3.4. Solder terminals are made in various versions and sizes. (Fig. 3.1-2 shows some typical forms of solder terminals; the actual range is found in the latest, appropriate leaflets.) The usual versions are made from a Teflon foil made suitable for adhesion by surface etching to which nickel-plated metal spots made from electrolytic copper are cemented with heat resistant adhesive. The continuous temperature stability is up to 180°C and up to 260°C for short-term operation. For temperatures under -70° C spot-welding should be used on polyamide carriers.

The size of the solder terminals is selected according to the gage size and to the thickness of the cable cores to be soldered. In installations involving high dynamic load, small soldering points are recommended. Bonding is done conveniently together with the gage (as detailed in section 2.3.4) using the same adhesive that is used for the strain gage.

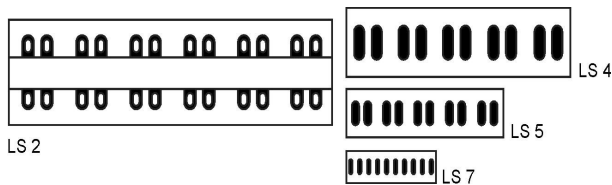

Fig. 3.1-2: Some forms of solder terminals (examples only)

3.1.6 Lead materials

The success of a measurement also depends on the correct selection of electrical connecting materials, including leads and cables. Cables must not only transmit the measurement signal, but must limit noise signals to an acceptable minimum, whilst being able to withstand the stress of the ambient conditions.

Short internal connections inside a transducer may be carried out with relatively thin wire or stranded wire. Core insulation should be good and withstand the expected temperatures. Good solderability of the cores is required. So-called “dynamic strands” may be advantageous if the measurement object is subjected to extreme dynamic stress. Its core consists of many very small strands which are covered by a flexible insulation. Wiring within the bridge must be symmetric. This means identical wires should have the same length.

Greater care is needed with longer connections and cables. The ohmic resistance must be kept within reasonable limits by selecting a conductor with an appropriate specific resistance and cross sectional area. Low capacitance cable is recommended for carrier frequency operation and for DC operation if high frequency signals are to be transmitted. A stranded copper shield is useful to make the core capacitance symmetrical and to protect against disturbing stray effects from electrical fields. To protect against magnetic fields, it is recommended to lay the cables in steel tubes.

Note 3.1-4:

Electrostatic influences occur if capacitive coupling of the electrical field of a voltage source occurs in the measurement circuit. The best protection is a closed screen around the lead or cable. This is usually stranded copper wire texture giving sufficient coverage. Special measurement cables are equipped with such a screen. It is important to properly earth the screen since a potential-free screen has no effect.

Electromagnetic influences occur if cables of the measurement circuit are routed near conductors, which carry current or are close to electrical equipment (e.g. generators, welding equipment, transformers, motors, etc.). According to the transformer principle, disturbing electrical voltages will be induced in the measurement cables. An efficient means of protection is twisting of the cores (ready-made cables have twisted cores). If this is not sufficient, additional shielding by a steel armoured tube or gas (water) tube can be employed.

The carrier frequency method is far less sensitive to electrical noise than the DC method since all disturbing frequencies outside the transmission band are eliminated by the carrier system.

It is important that cable insulation has a high dielectric resistance, which is not affected significantly by changes in temperature, humidity, etc. (see Tables 3.1-2 and 3.1-3). When using carrier-frequency measurement instrumentation, low capacitance cable should be used especially if long cable lengths are necessary.

For half- and full-bridge circuits, a balanced condition between adjacent bridge arms should be preserved, with respect to both the resistance and capacitance of the conductors (see note 3.1-6). The cable sheathing shall protect against ambient effects and shall be resistant against humidity, water, oil, chemicals, (high and low) temperatures, and mechanical stresses. Commercially available measurement cables comply with many requirements but there is no cable to suit all requirements.

Table 3.1-2 lists the most important insulation materials along with some notes on their properties.

Material name	PVC Polyvinylchloride	PE Polyethylene (low density)	PTFE Polytetrafluoride ethylene (Teflon)	PUR Polyurethane	SIK Silicon rubber	PA Polyamid	PI Polyimid	Glass fibre roving	Glass fibre sleeving	Stealth pearls
Temperature stability °C continuous short-term	-50...80 ...90	-80...80 ...100	-100...260 ...300	-60...90 ...100	-80...180 ...250	-55...105 ...125	-269...275 ...400	-269...280 ...480	-269...400 ...600	>600
Specific resistance at 20°C	10 ¹¹ ... 10 ¹⁵	10 ¹⁶	>10 ¹⁸	10 ¹¹ ... 10 ¹⁴	10 ¹⁴ ... 10 ¹⁵	10 ¹² ... 10 ¹³	10 ¹⁴ ...10 ¹⁶	-	-	
Abrasion resistance	mediocre	mediocre	moderate	very good	moderate	very good	very good	moderate	moderate	very good
Inflammability ¹⁾	Self-extinguishing	Inflammable	Not inflammable	Self-extinguishing	Self-extinguishing	Flame resistant	Self-extinguishing	Not inflammable	Not inflammable	Non-inflammable
Resistance against acids	Good	Very good	²⁾ Very good	Poor	³⁾ Good	A: not resistant L: good	A: very good L: not good	Good	Good	Very good
And lye	Moderate	Good	Very good	Good	Not resist.	Good	Good	Very good	Very good	Very good
Oil	Mostly not resistant		Very good	Not resist.	Lim. Resist.	Good	Mostly resistant	Very good	Very good	Very good
Solvents			Very good	Not resist.	Lim. Resist.	Good	Mostly resistant	Very good	Very good	Very good
Water absorption %	1...2	0	0	1,4	0,1...0,4	2...10	1...3	-	-	-

¹⁾ not resistant against molten alkaline and fluor

²⁾ not resistant to steam over 130°C

Table 3.1-2: Most important cable or lead insulation materials and some of their technical data.

Note 3.-5:

Up-to-date information about the current program of cables offered by HBM should be taken from the latest instruments price list. Connection wires and stranded wires are included in the strain gage price list.

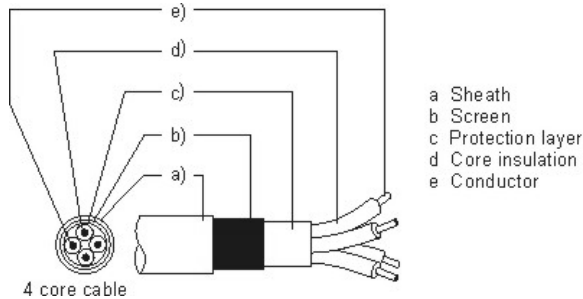

Fig. 3.1-3: Construction of an HBM cable

Note 3.1-6:

HBM cables are distinguished by a very good capacitive symmetry, there are no systematic deviations even with long cable runs. The resistive asymmetry is practically insignificant (there is no difference in the resistance of different cores). A symmetry test can be used to locate faults, e.g. in wrong plug connections, soldering connections, or sometimes defective cables. The following considerations apply to the use of carrier frequency instruments.

Test with capacitance bridge (measuring frequency preferably 1000..10 000 Hz):

The capacitances

- (1) 1 + screen with respect to 2 (C1,2) and 1 + screen with respect to 3 (C1,3) shall be equal. Permitted differences are 100...200 pF, independent of cable length. Same condition for 3 core cable.
- (2) 4 with respect to 2 (C4,2) and 4 with respect to 3 (C4,3) shall be equal. Permitted differences are 100...200 pF, independent of cable length.

Different capacitances measured per 1 or 2 are of no importance. It might be quite significant due to the screen being connected to core no. 1 (30%). If connections are correct, the symmetry can be balanced with additional capacitors. Such capacitors may be connected at either end of the cable.

3.2 Practical hints

3.2.1 Hints for soldering

- Remove oxide layers from solder tabs (see 3.1.5) prior to bonding with a glass fibre eraser, then clean with RMS 1 and Q tip.
- Prior to soldering the cables: Pre-tin solder tabs; twist strands of stranded wires (between papers, not with unprotected fingers) and pre-tin. Touch object to be soldered with tip of solder bit, add solder with resin core in such a way that flux completely wets solder spot. In the case of solid solder wire, first wet solder spot with colophony dissolved in alcohol (order no. 1-FSO1). Use flux and solder only sparingly!
- Soldering the cable cores: Place pre-tinned core end onto pre-tinned solder tab or introduce in solder tag, fix with self adhesive tape if necessary, and make solder connection **without further solder**.

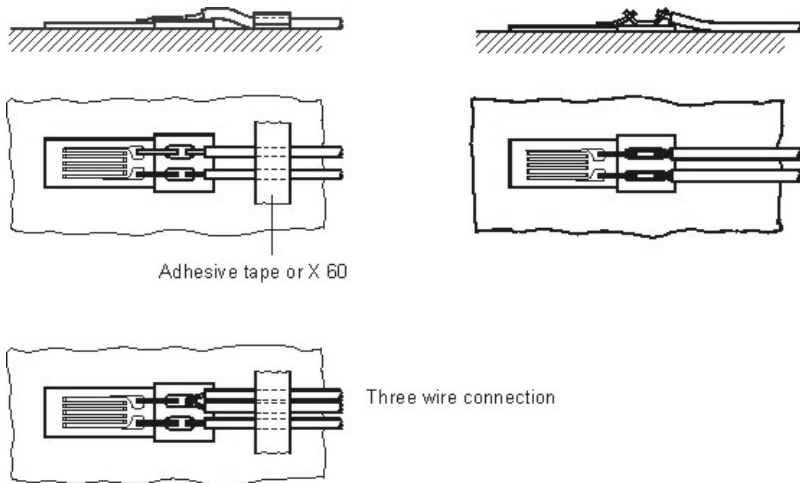

Fig. 3.2-1: Soldering cable cores to strain gages with ribbon leads

In the case of strain gages with solder tabs (see fig. 2.3-4, sketch b) it is recommended to use extra solder terminals, too (as shown in Fig. 3.2-1). The connection between solder tab and the solder terminal should be flexible. It is useful to have one strand of the cable core to further connect from the terminal onto the solder tab of the gage (see Fig. 3.2-2). Avoid short circuits to the specimen due to unsecured conductors! If necessary, bond insulating foil underneath.

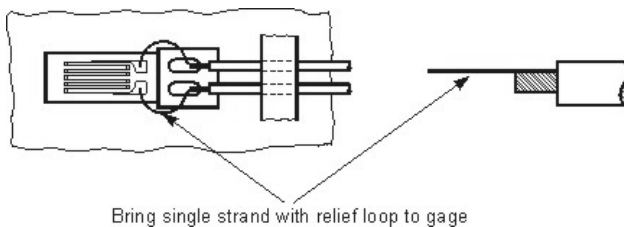

Fig. 3.2-2: Connection of cable cores to strain gages with open solder tabs

- Keep soldering iron steady during soldering until solder flows, which should happen within say 3 seconds (otherwise overheating of solder spot).
- Quick motions of the solder iron during soldering will impair heat transfer (results in dry joints).
- During solidifying, the solder parts must not be moved (will make joints defective).

- Do not try to speed up solidification of solder by blowing (will produce hair cracks leading to fatigue breakage).
- Contours of parts joined by soldering shall still be visible. They must not be buried in a mass of solder.



Fig. 3.2-3

- The edges of the soldered spots will tell you if all parts have been properly wetted



Fig. 3.2-4

- Be careful not to produce shorts to earth due to metallic strands touching the specimen.
- Remove flux residues. Colophony by means of pure spirit, isopropyl alcohol or RMS1, must be washed off completely.
- Check solder connection with magnifying glass.

Note 3.2-1:

Flux residue, even from colophony may give rise to changes of the insulation resistance. This will be the case even if only small amounts of humidity diffuse into the material or migrate from it through drying. Furthermore colophony, like other resins, will change its insulation resistance drastically depending on temperature. The insulation resistance of an installed strain gage can easily be measured with respect to the specimen but not between the two connections of the gage. A variation of the insulation resistance, however, between the connections will result in a drift of the zero point that is attributed to the gage itself, which is wrong. For that reason it is of utmost importance to remove all flux residue with greatest care.

3.2.2 Hints for the connection of cables

- When making transducers, always use strain gages in full bridge circuit. The internal bridge connections should be kept as short as possible. Make sure that the connections in all bridge arms are the same length (the connections in neighbouring bridge arms should at least be the same length).
- It is recommended that an additional strain relief be used on the measuring cable, e.g. by pasting the cable end with quick fixing adhesive X60.

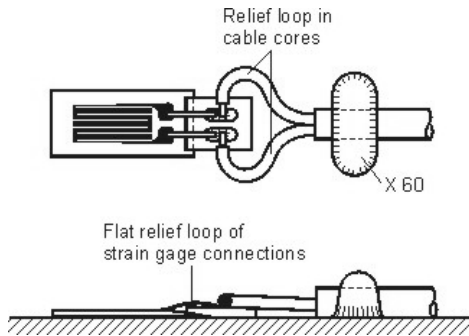

Fig. 3.2-5

The remaining cable can be fixed with cable clips in the usual way, adhesive cable clips are especially easy to use (they can also be screwed on).

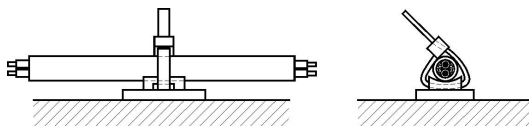

Fig. 3.2-6:

- After connecting the cables, any flux residue must be removed very carefully, before checking the insulation resistance and the cable resistance (see note 3.2-1).
- If the strain gage installation is subjected to extreme conditions, e.g. pressurised water or by underwater storage, for longer periods of time, it is better to remove the cable sheath over a length of approx. 5 to 10 cm. This enables the cable cores to be **individually** embedded in the covering medium. This will result in very long migration distances at that spot, which is in greatest danger i.e. the cable exit from the protective cover (for further details on protective covers see section 5.).

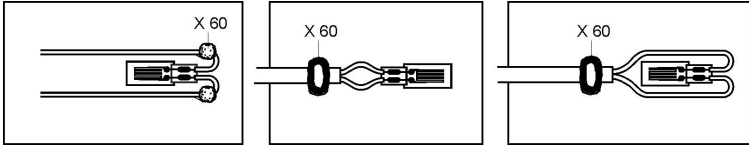

Fig. 3.2-10

4 Intermediate tests

4.1 Visual inspection

The strain gage and the cable connections should be checked using a good magnifying glass with 6x enlargement, for following defects:

- Air bubbles underneath the strain gage
- Poor bonding at the edges
- Unreliable solder connections
- Flux residue

4.2 Electrical continuity of the strain gage

All strain gages delivered are adjusted to close tolerances of the nominal resistance. A control measurement should reveal if the strain gage resistance has changed by a significant amount after bonding (changes up to 1/4% are tolerable).

4.3 Resistance of the connection cables

The resistance of the connection cables produces an apparent reduction of the strain gage sensitivity, for a given excitation voltage. Therefore, the resistance shall be measured and recorded in the protocol. The “known systematic error” from the cable resistance shall be corrected when evaluating the measurement (see also [2], section 4.2).

Note 4.4-1:

Example: At a distance between strain gage and amplifier of 20 m using a standard cable with a core cross section of 0.17 mm² the resistance will be 4.23 Ohm (both ways). This results in a loss of sensitivity of

3.4% with 120 Ohm strain gages

1.2% with 350 Ohm strain gages

0.6% with 700 Ohm strain gages

4.4 Insulation resistance of the strain gage

The insulation resistance of the strain gage shall be measured relative to earth. Use instruments with test voltages below 50 Volt.

A strain gage installed in the laboratory or under similar conditions should have an insulation resistance of at least 20000 M(Ω) at room temperature. If installed outdoors at least 2000 M(Ω) should be obtained. Further details can be found in [2] section 4.3.1. Low insulation resistance either indicates insufficient cleaning of the solder connections (see section 3.2.1), or later

contamination, e.g. by perspiration on fingers, or absorption of humidity. The latter may come from humid atmospheres. In this case, heating of the installed gage is advisable until a sufficiently high and stable insulation resistance is obtained (heating up to 80...100°C if cold curing cement has been used, 120..180°C for hot curing cements).

4.5 Insulation resistance of the connection cable

The insulation resistance between the cores of the connection cable depends on the quality of the insulation materials (see note 3.1-6) as well as on the cable length. It should be of the same magnitude as the insulation resistance of the strain gage itself.

5 Protection of the installed strain gage

Installed strain gages must be protected against mechanical and chemical influences. Even under ideal conditions, such as in a laboratory, the properties of the installed gage will deteriorate with time if no suitable countermeasures are taken. The variety of such countermeasures is as diverse as the influences on the gage. In the laboratory with controlled low humidity it might well be sufficient to have just a light seal against touching with fingers (perspiration), while in the rough ambient conditions of a rolling mill, full protection against vapour, water, oil, heat, and mechanical influences will be required. In the first case, a simple varnish seal will be appropriate, in the latter case one has to build several layers from different protective covers to make a good barrier.

Absolute protection over long periods of time is only possible by hermetic sealing. This level of protection is, therefore, used in commercially available transducers, provided the function permits it. All other covering agents, even the very best, will only provide protection for a limited period of time. The protection time will depend on the type of the cover, its thickness and on the nature of the attacking medium. The period of proper protection could last from a few hours up to several years, depending on the prevailing conditions. The required duration of protection depends on the duration of the individual measurements. Additional issues include the possibility of checking the zero point in between measurements and the required accuracy.

Slight impairments of the bonded strain gage, e.g. by diffusion of humidity will mainly result in changes of the zero point. If these can be controlled, e.g. by removing the load from the specimen, and if they remain within acceptable limits (e.g. 100..200 $\mu\text{m}/\text{m}$) one could go ahead with stress analysis measurements with sufficient accuracy. Another indicator of the suitability of an installed strain gage is the insulation resistance. If the insulation resistance reduces from 1000 M Ω to 1 Ω , there will be a zero shift of -60 $\mu\text{m}/\text{m}$ in a 120 Ohm gage, of -175 $\mu\text{m}/\text{m}$ in a 350 Ohm gage, and -350 $\mu\text{m}/\text{m}$ in a 700 Ohm gage. This means that the lower limit of the insulation resistance is a function of the gage resistance.

Diffusion of etchants, conductive materials or corrosion can severely impair the installed strain gage. Corrosion will be greatly increased by using DC excitation of the strain gauges. Experience has shown that local galvanic elements are formed, the voltage of which is superimposed on the measurement signal, leading to large measurement errors. Finally, it should not be forgotten that protection requirements for the strain gage also apply to the connections, cables, etc. (see also section 3.1.6).

Any protection measure should be effective but must not change the mechanical properties of the specimen. Thin objects should not be made so stiff that deformation under load is prevented. Protection materials containing solvents or other aggressive chemicals should not be used on plastic specimens.

It is certainly not possible to give instructions for each individual case. However, the following hints should be sufficient to establish the appropriate countermeasures for the majority of problems encountered.

5.1 Some hints for the use of protective covers for installed strain gages.

Considerations for the selection of covering agents:

- Ambient conditions (see also [22]: "Chemical resistance of HBM protective coatings")
- Duration of the measurements or the required life
- Required accuracy
- The thin or weak specimens must not be mechanically supported by protection material, thereby effecting the measurement.
- The material that will be in contact with the strain gage and the connections must have a very high insulation resistance and should not give rise to chemical reactions or corrosion.

The following applies to the covering agent:

- The installed strain gage must be in perfect condition **before being covered**. Trapped humidity, perspiration, flux residue from soldering and the like are time bombs, which sooner or later will lead to false measurements or even to complete failure. Remember, efficient protective covers are not only a seal against outside humidity but they also seal in trapped humidity.
- The cover should be put on immediately after the bonding of the strain gage.
- If bonding the strain gage in humid ambient conditions cannot be avoided due to inadequate time, bad weather, wet rooms, the specimen should be baked in an oven (temperatures at say 110...120°C, if possible). If this is not available or feasible, the installed gage should be dried with a hot air gun or hair dryer.
- The covering agent should adhere perfectly to the area surrounding the installed gage. Imperfections and capillaries (scratches, scars, and grooves) allow the penetration of aggressive media. The bond of the covering agent with the surrounding area should maintain the same quality over the whole useful life of the strain gage installation. For that reason this area should be cleaned as carefully as the bond area of the gage and should be about 1 or 2 cm larger than the covered area. Perspiration (fingerprints) could lead to rust creeping under the cover, which was initially perfect, thus making the cover ineffective.
- Cable exits shall be sealed with utmost care. The covering agent must completely enclose the cable ends, even underneath, in order to prevent any channels or capillaries that could allow moisture get into the cover. In the case of multicore cables, each core shall be enclosed within the covering agent, and part of the cable sheath should also be covered by the protective cover. Fig. 5.0-1 shows an example.

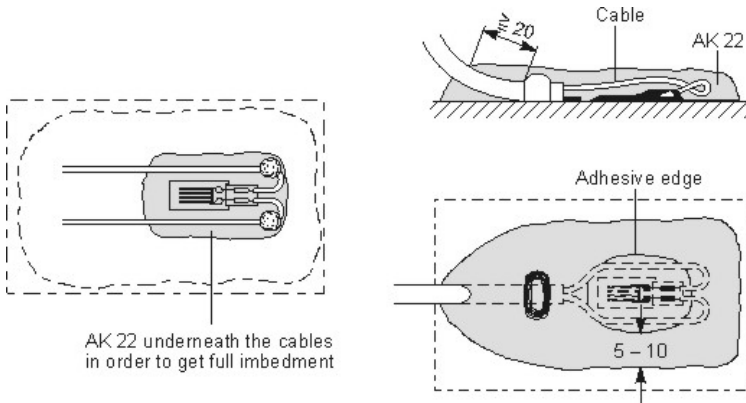

Fig. 5.0-1: Installed strain gage with protective cover

- Please follow the instructions for use when using commercial covering agents.

5.2 Popular protecting materials

- Polyurethane varnish PU 120

Air drying varnish. Suitable for light protection against touching (perspiration) and dust. Also provides protection against the variation in ambient humidity. Likewise useful as insulating layer under other covers. Oil resistant. Good abrasion resistance.

Caution: Do not use in combination with NG 150!

- Nitrile rubber varnish NG 150

Air drying varnish.

Range of installation and properties similar 10 PU 100. Oil and petrol resistant, preferred if in contact with liquefied gases (excluding oxygen!).

Caution: Do not use in combination with PU 120!

- Silicon varnish SL 450

Air drying varnish.

Preferred for the protection of ceramic cements (high temperature installations) against absorption of humidity and dirt.

- AK 22, permanently plastic putty

Advantages:

Easy to use by kneading on.

Excellent adhesion due to strong “stickiness”.

Very good protection against humidity and water; can be used under water. Useful life in 20°C water up to 1 year, in 75°C water up to approximately 3 weeks.

Tested in pressurised water up to 400 bar for several days, limit not known. Very good weather stability.

The long term protection can be greatly enhanced by kneading on some aluminium foil as a diffusion barrier (household foil).

Mechanical protection against mechanical shocks or falling pieces is easily achieved by pressing on some sheet metal. Temperature stability in air from -50... + 170°C. Unlimited shelf life.

Disadvantages:

Not resistant to oil and solvents.

Cannot be used under high centrifugal forces on the outer perimeter of rotating bodies.

- ABM 75, permanently plastic putty with aluminium foil

Range of installation and properties similar to AK 22, with following differences:

The material is supplied in strips laminated to a 50 µm thick aluminium foil, which is a diffusion barrier.

The temperature range is from -200...+75°C.

- SG 250, transparent, solvent-free silicon rubber.

Suitable as protection against humidity and weather, against water at room temperature, limited resistance to oil.

The rubber like cover makes a very good mechanical protection.

Temperature stability from -70... +180°C, short term to 250°C: in this range the material will be elastic.

- Petroleum jelly, unbleached

Advantages:

Low cost, easy to use; very good protection against humidity and water, can be used under water.

Disadvantages:

Cannot be used in flowing water, rain or spray water. Might be wiped unintentionally from open spots; will melt at, say 50°C.

- Silicon grease

You are warned not to use silicon grease despite good properties because it easily transfers to tools and further onto other parts. Due to its very good adhesion silicon grease is difficult to remove without leaving a residue. Even minute traces will prevent perfect bonding of strain gages.

- Micro-crystalline waxes

Good protection against humidity and general atmospheric conditions.

Requires installation in molten state onto warmed up specimen in order to obtain proper adhesion. Only slight mechanical protection.

Temperature range from approx. -70... +100°C

- Poly-sulphide rubber

Two-component material, makes rubber-like materials, which are excellently resistant against solvents and are non-ageing. They are also distinguished by their good weatherproof properties.

Temperature range from -50... +120°C.

- Epoxy resins (trade name: Araldite, UHU plus etc.)

This material is a two-component resin. Mixtures that do not set too hard setting are suitable for strain gage covers. It is quite suitable as protection against oil, motor fuels, thinned acids, thinned lyes, many solvents and will also give good mechanical protection. Temperature limits depend on curing conditions (cold or hot curing possible).

- Aluminium Foil

Self adhesive tapes laminated with aluminium foil are a good barrier against water vapour (diffusion barrier). When used as an additional cover, these are suitable to improve the properties of other covering agents, especially their long-term stability. Aluminium foils are also well suited as an extra cover for connection cables, which often are the weakest link within the measurement point.

- Liquid means for protection of installed strain gages

Some problems of the protection can be solved by using insulating liquids. As an example, let us look at an installation inside a small vessel that is to be pressure tested. If something other than the usual pressure medium, water, can be used, many problems can be resolved quite simply. Prerequisite is that the selected pressure medium has best insulation properties and is free from additives, which might attack the strain gage. The following media could be used:

- water and acid-free oil,
- paraffin oil,
- pure petroleum.

This type of protection with liquid has already been successfully used to protect permanently installed measurement points. In that case, a capsule around the mounted strain gage is filled with the protective medium. In this connection another very good medium should be mentioned:

Poly-isobutylene of which the low molecular versions flow like oil or are tough like honey (trade name: Oppanol B3, Bio, and B15).

- Combinations

Sometimes a single covering agent is not enough to ensure proper protection of the measurement point. Some examples for the combined use of several agents have already been discussed under AK 22 and ABM 75. If you wish to add additional mechanical protection to the metal foil, it is recommended to add an extra layer of silicon rubber SG 250.

In many cases, a number of different media, e.g. oil and water, attack a measurement point. In such cases, for example, a layer of ABM 75, which is not oil resistant, should first be used. The aluminium foil, as the diffusion barrier, is the second layer and on top of this the oil resistant epoxy resin is the third layer.

In the case of seawater, multilayer protection is absolutely necessary. The top layer, which will not be in contact with the strain gage, could be any other material not mentioned here, e.g. asphalt. However, such materials must not dissolve or chemically attack the lower layers. There are no requirements regarding their insulation resistance.

The problem of the proper protection of installed strain gages has so many facets permitting only a very general survey of the field. It is recommended that, wherever possible, tests be carried out under true conditions in all critical cases.

6 Literature

- [1] VDI/VDE-Richtlinie 2635, Blatt 1: Dehnungsmessstreifen mit metallischem Messgitter; Kenngrößen und Prüfbedingungen. Beuth-Verlag GmbH, Berlin 30 und Köln 1.
- [2] Hoffmann, K.: Fundamentals of the strain gage technique
Heft VD 72001: Die Anwendung der Wheatstoneschen Brückenschaltung (1973)
Heft VD 78001: Maßnahmen zur Vermeidung bzw. Verminderung von Messfehlern (1978)
Publications of Hottinger Baldwin Messtechnik GmbH, Darmstadt
- [3] Michel, M.: Adhäsion und Klebetechnik
Carl Hanser Verlag München (1969)
- [4] Mittrop, F.: Das Kleben als Befestigungsverfahren für Dehnungsmessstreifen in „Haus der Technik e.V. Essen Vortragsveröffentlichungen“ Heft 31 (1965), S.15/27
- [5] DIN 53281, Teil 1: Prüfung von Metallklebstoffen und Metallklebungen - Proben - Klebe-Flachenvorbehandlung Sept. 1979
Beuth Verlag GmbH, Berlin 30 und Köln 1.
- [6] Kleinert, H. und W. Krimmling: Das Alterungsverhalten von Metallklebeverbindungen in Abhängigkeit von der Oberflächenvorbehandlung der Füge-teile.
Plaste und Kautschuk 12 (1965), H. 8, S. 472/475.
- [7] Datasheet “Strain Transducers DB1, DA2, and DA3”.
Hottinger Baldwin Messtechnik GmbH, Darmstadt.
- [8] Datasheet “Strain Transducer 01”.
Hottinger Baldwin Messtechnik GmbH, Darmstadt.
- [9] Datasheet “Strain Transducers DD1”.
Hottinger Baldwin Messtechnik GmbH, Darmstadt.
- [10] N.N.: Nullpunktstabilität von DMS-Messstellen auf Steingut.
Messtechnische Briefe 3. Jg. (1967), H 3, S. 52.
Hottinger Baldwin Messtechnik GmbH, Darmstadt.
- [11] VDI-Richtlinie 3821 (Sept. 1978): Kunststoffkleben, Beuth-Verlag GmbH, Berlin 30 und Köln 1.
- [12] Merkblatt DVS 2204: Kleben von thermoplastischen Kunststoffen, Teil 2: Polyolefine (Februar 1977).
Deutscher Verlag für Schweißtechnik (DVS) GmbH, 4000 Düsseldorf.
- [13] Oberbach, K., und G. Heese: Dehnungsmessstreifen-Hilfsmittel zum Prüfen von Kunststoff-Formteilen.
Kunststoffe 64 (1974) H. 9, S. 488/493.
- [14] Kern, W. F.: Messelemente für die Anwendung auf Gummiprodukten. VDI-Bildungswerk, Manuskript BW 2556 (1973).
- [15] Diehl, K., U. Hanser und W. Hort: Erfassung mechanischer Beanspruchung von Skeletteilen bei der Osteosynthese mittels Dehnungsmessstreifen.
Medizinisch-orthopädische Technik 95 (1975) H. 3, S. 72/74.
A. W. Geutner-Verlag, Stuttgart. I
- [16] Körber, K. H.: Elektrisches Messen mechanischer Größen in der zahnmedizinischen Grundlagenforschung.
Messtechnische Briefe 6. Jg. (1970) H. 2, S. 38/43.
Hottinger Baldwin Messtechnik GmbH, Darmstadt.
- [17] Kramer, J.: Messung der Zugkräfte bei Anwendung der Wirbelsäulenstreckbandage.
Messtechnische Briefe 6. Jg. (1970) H. 2, S. 44/45.
Hottinger Baldwin Messtechnik GmbH, Darmstadt.

- [18] Windecker, D.: Untersuchungen der Belastbarkeit und der Verformung von zahnärztlichen Prothesen mit Hilfe von Dehnungsmessstreifen.
Messtechnische Briefe 7. Jg. (1971) H. 2, S. 34/40.
Hottinger Baldwin Messtechnik GmbH, Darmstadt.
- [19] Reuther, J.F.: Druckplattenosteosynthese und freie Knochentransplantation zur Unterkieferrekonstruktion - Experimentelle und klinische Untersuchungen.
Med. habil.-Schrift, Johannes Gutenberg-Universität, Mainz (1977).
- [20] MAK-Wert-Liste 1978, Abschnitt III A2).
Carl Heymanns Verlag KG; Köln 1, Best.-Nr. ZH 1/401.
- [21] Macintosh, R.M.: Zinn bei tiefen Temperaturen
Zeitschrift „Zinn und seine Verwendung“, Nr. 72 (1967), S. 6/10.
- [22] “Strain gages and accessories”
Hottinger Baldwin Messtechnik GmbH, Darmstadt
- [23] Hoffmann, K.: An Introduction to Measurements using Strain Gages
Publisher: Hottinger Baldwin Messtechnik GmbH

Modifications reserved.

All details describe our products in general form only. They are not to be understood as express warranty and do not constitute any liability whatsoever.

Hottinger Baldwin Messtechnik GmbH

P. O. B. 100151 · D-64201 Darmstadt

Im Tiefen See 45 · D-64293 Darmstadt

Tel.: +49 6151 803 0 · Fax: +49 6151 803 9100

E-mail: support@hbm.com · www.hbm.com



measurement with confidence